

# Château de Sceaux

Échelle : 1/280 ème

© 1999 - P. Gauriat

version 1.2 - décembre 1999 - prototype

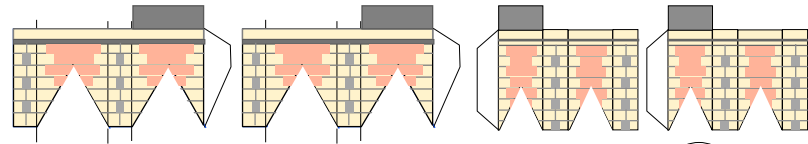

19 sur 8    20 sur 9    21 sur 10    22 sur 11

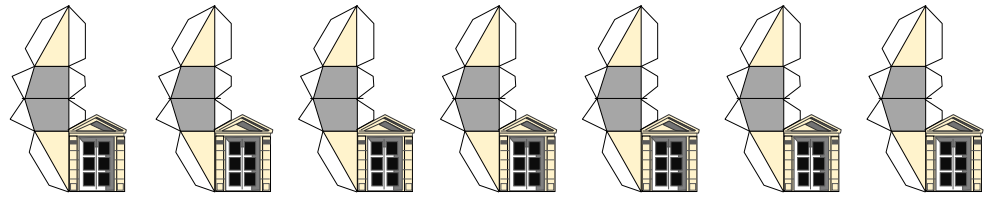
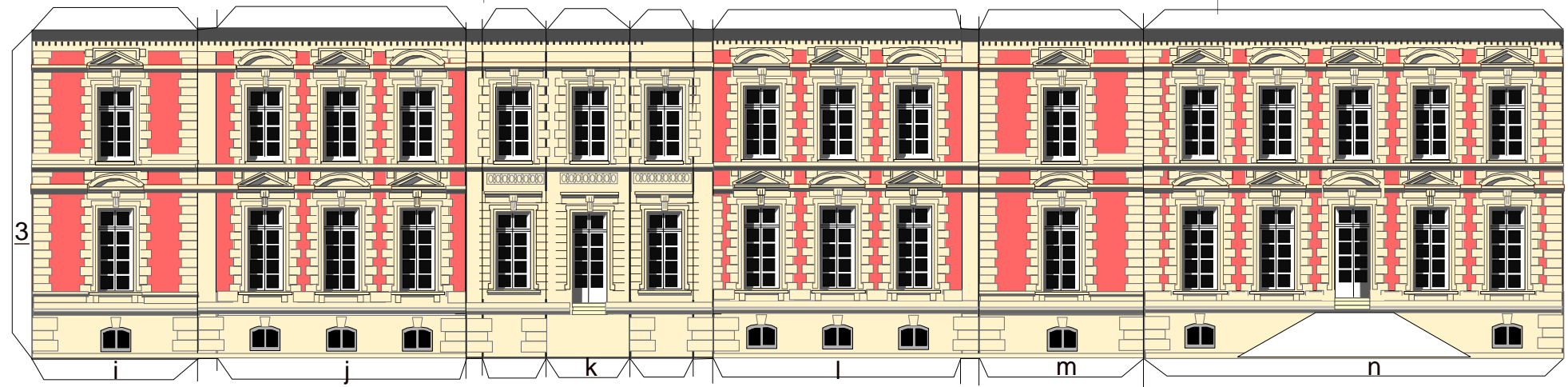
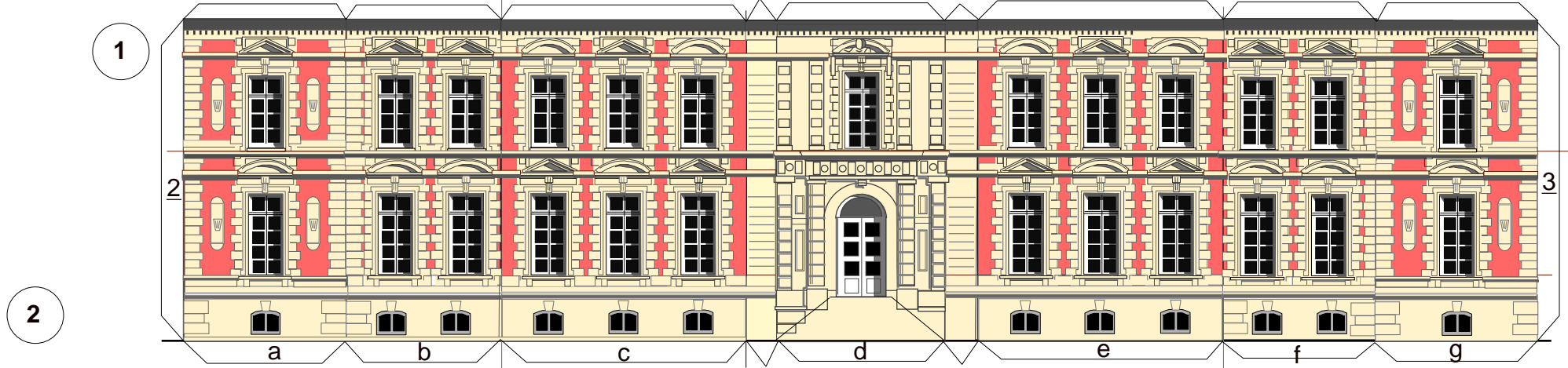

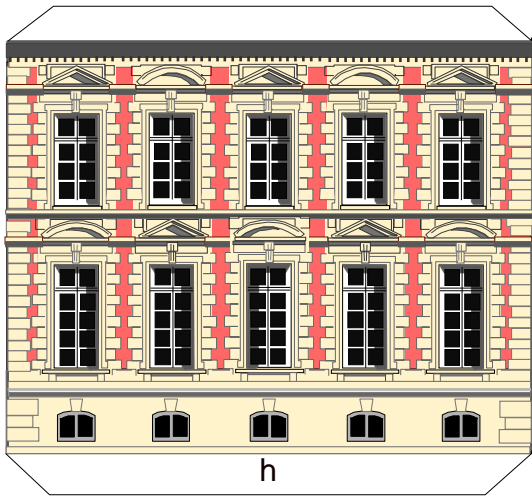

3

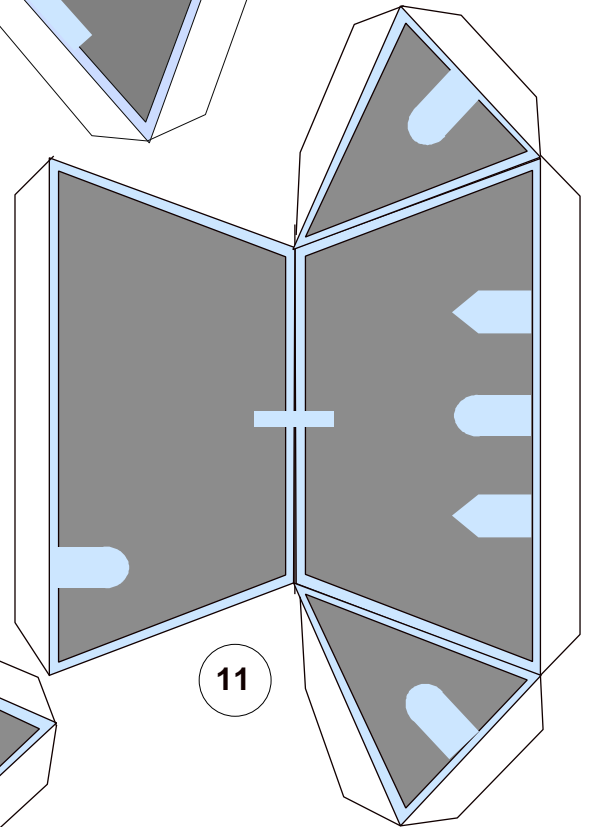
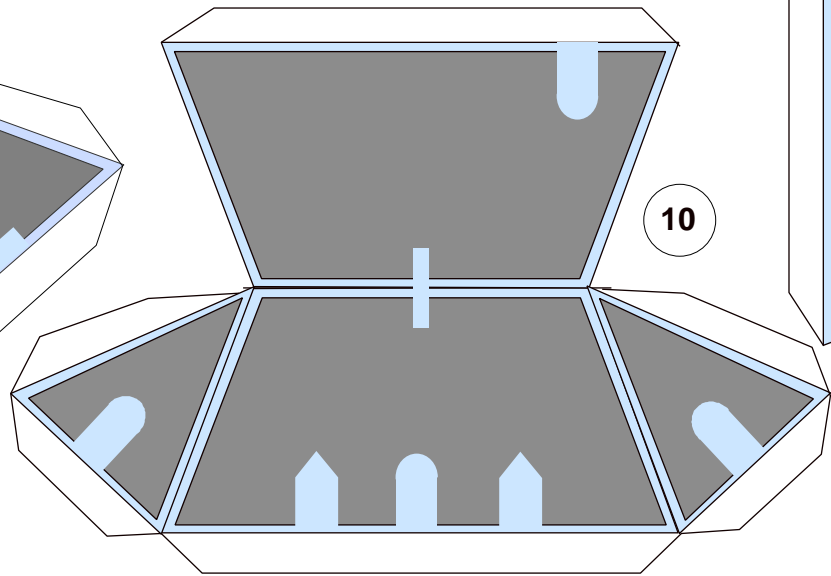
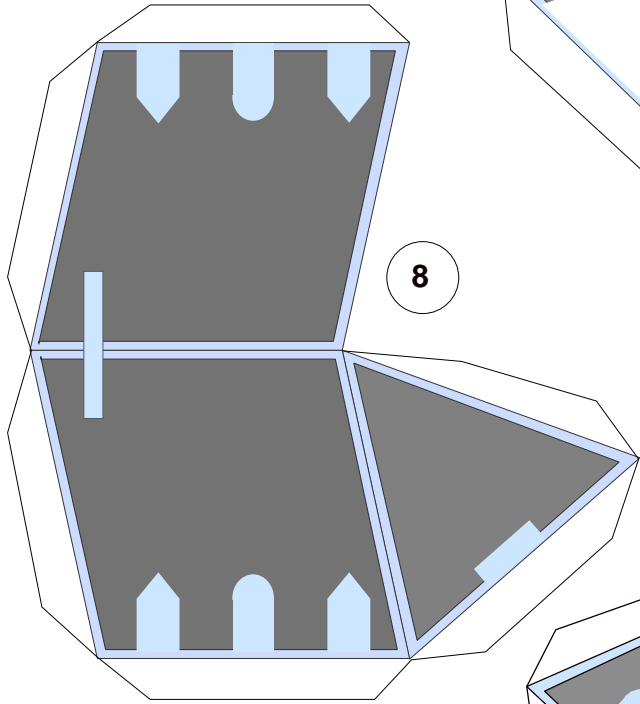
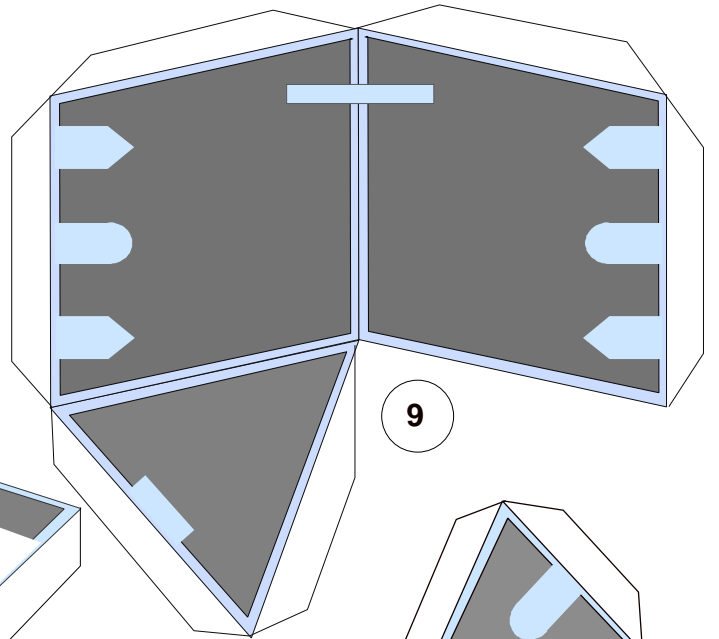
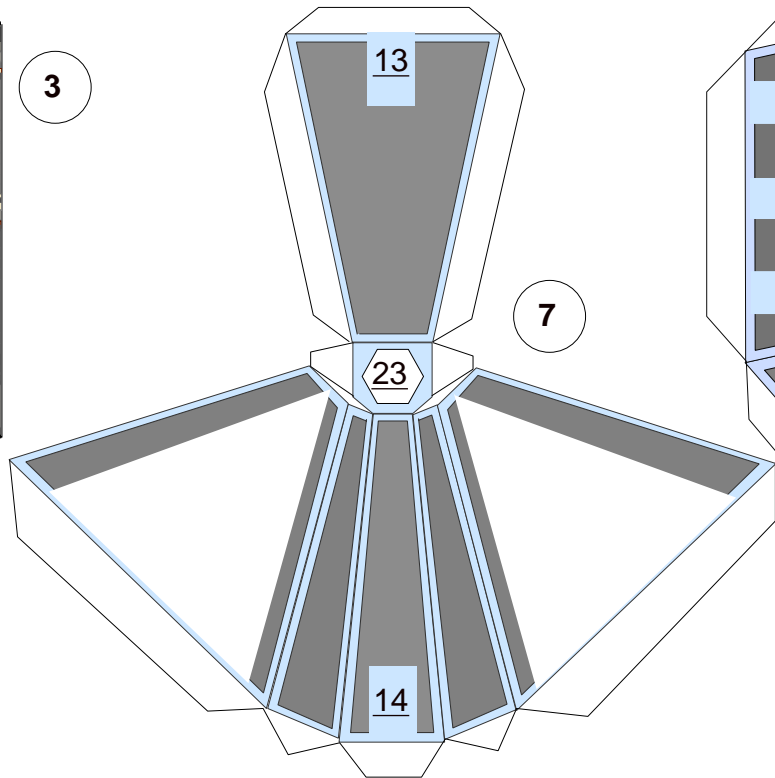

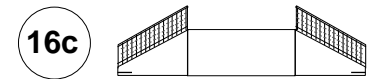
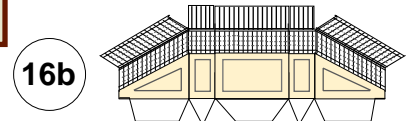
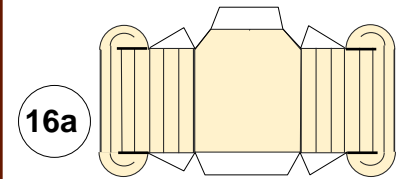
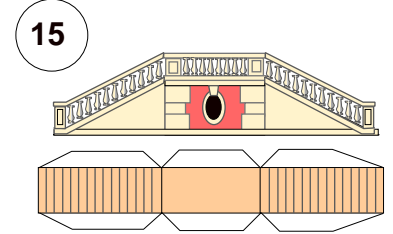
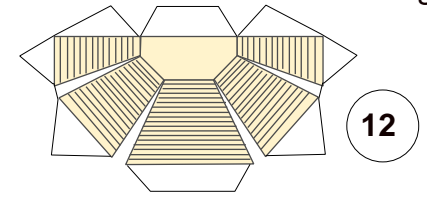
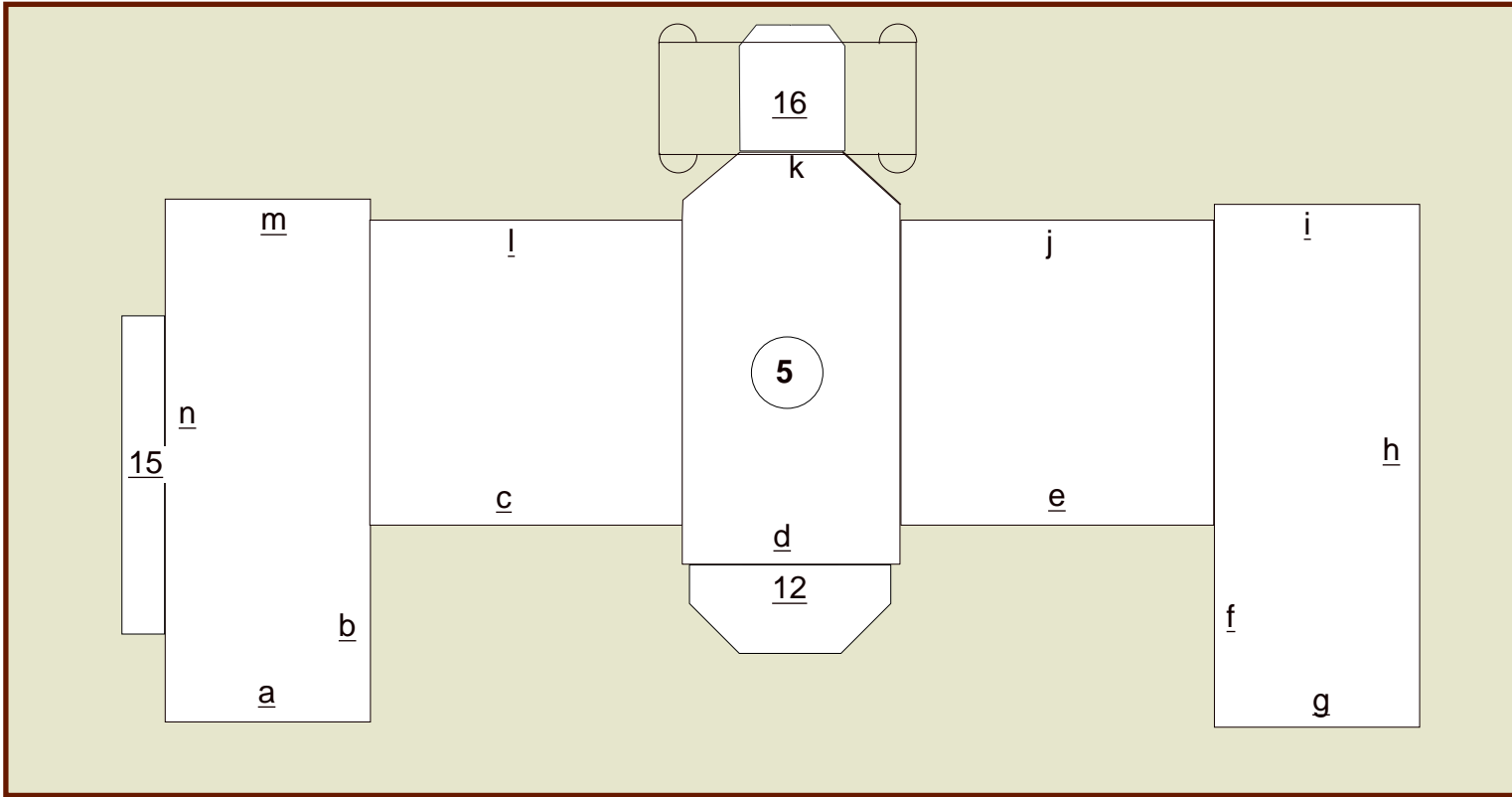

Assembly of stairs #16

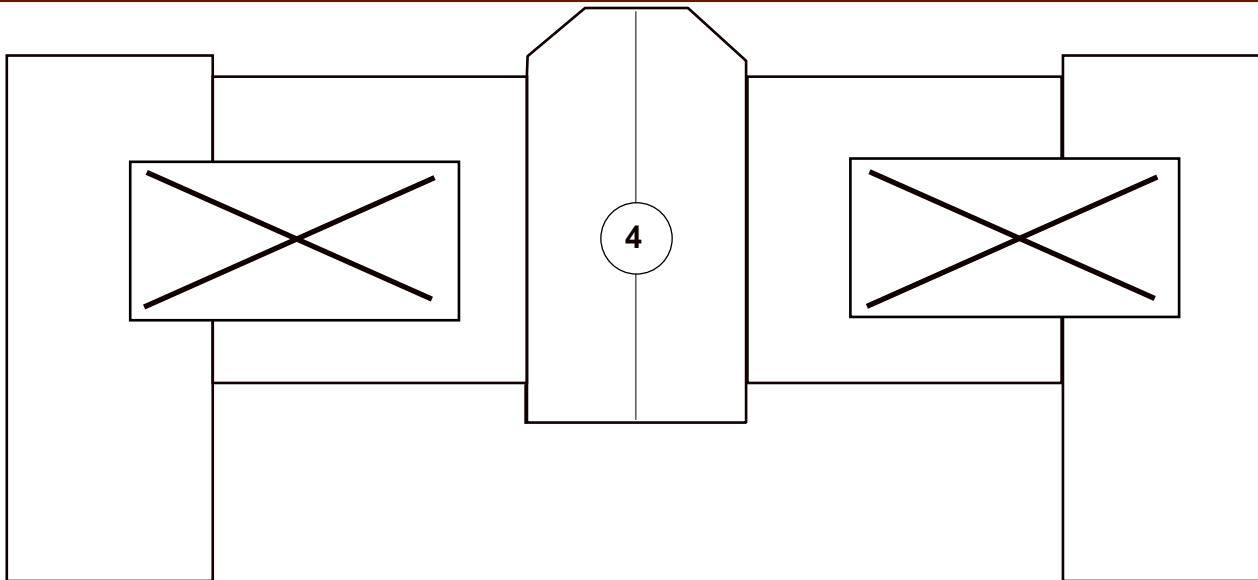
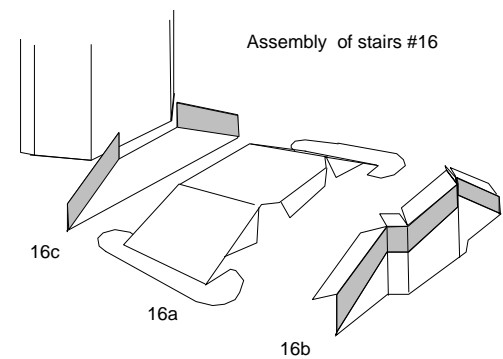

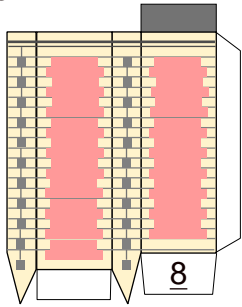

17

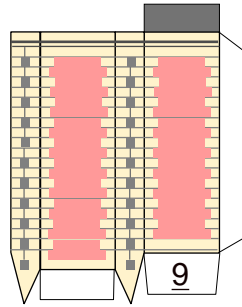

18

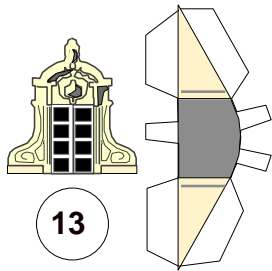

13

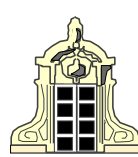

14

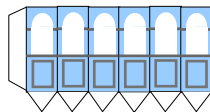
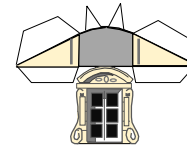
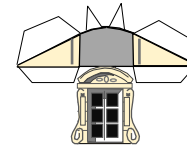
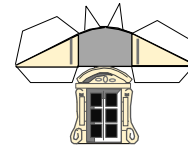
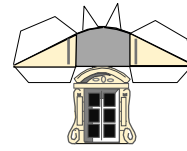
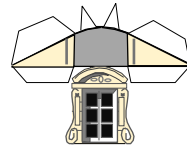
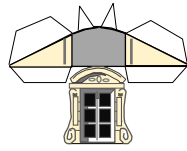
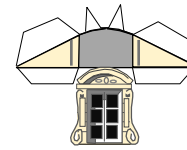
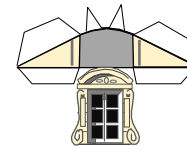
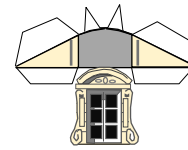
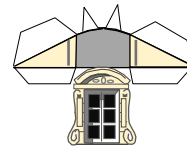
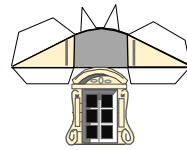
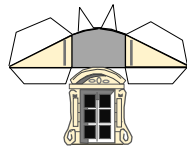
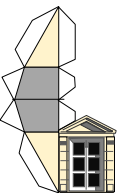
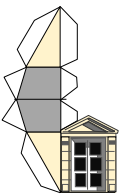
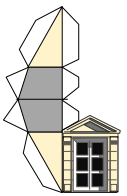
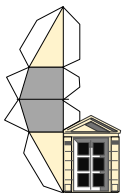
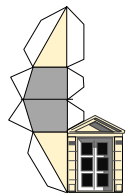
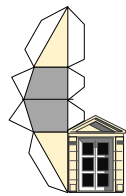
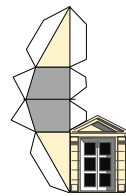
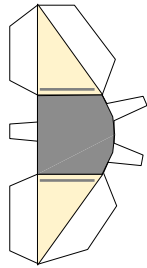

23

